

COOL IT[®] Thermo Tec



FULL PRODUCT LINE

THE ORIGINAL INVENTOR OF HIGH PERFORMANCE
EXHAUST INSULATING AND HEAT CONTROL PRODUCTS



AN AMERICAN ORIGINAL FOR OVER 30 YEARS

Utilizing extensive research and development since 1987, Thermo-Tec produces the highest quality products for heat insulating, heat protection, and acoustical control. Our products out perform the competition in the automotive, motorcycle, powersport, marine and aviation industries. Several disciplines of racing, from grassroots to professional race teams, depend on Thermo-Tec high performance products. It's our reputation for producing the highest quality and best performing products that keeps racers, and automotive enthusiasts alike, using our winning products.

Year after year, our loyal domestic and international customer bases have provided the Thermo-Tec brand with sales growth in every category. Our commitment to quality and continuous improvement is our pledge to you and our continued growth.

Extreme heat conditions and the destructive nature of radiant heat in general continue to be a major problem for consumers of our products. They find that Thermo-Tec products provide logical, easy-to-use solutions at reasonable prices.

Customers may contact us at anytime for heat and sound management solutions. The Thermo-Tec Team is at your service, willing to match ideal products to your needs.

TABLE OF CONTENTS

EXHAUST INSULATING

- 5 Rogue Series Exhaust Insulating Wrap • Platinum Exhaust Insulating Wrap
- 6-7 Original Exhaust Insulating Wrap • Graphite Black Exhaust Insulating Wrap • Generation II Copper Exhaust Insulating Wrap • Exhaust Insulating Wrap Kits
- 8-9 High Velocity Exhaust Jackets • Header Manifold Blanket • Stainless Steel Clamp-On Heat Shield • Clamp-On Heat Shield
- 10-11 Turbo Insulating Kit • T3-T4 & T5-T6 Turbo Cover • Rogue Series Turbo Cover / Kit • Kevlar Muffler Cover

COATINGS & ADHESIVES

- 12 Hi-Heat Coating • Heavy Duty Spray Adhesive

FASTENERS, TAPES, ROLLERS

- 13 Snap-Strap™ • Seam Tape • Mat Roller

SOUND & HEAT BARRIERS

- 14-15 Cool-It Mat™ • Thermo-Guard FR™ • The Suppressor™ Heat and Acoustical Mat • Super Sonic Acoustical Mat™

SLEEVING

- 16-17 Thermo Sleeve™ • Express Sleeves™ • Ignition/Plug Wire Sleaving • Cool-It™ Plug Wire Sleeves
- 18-19 Spark Plug Wire Heat Shield • Heat Sleeves™ • Thermo-Flex

HEAT SHIELDS & PROTECTION

- 20-21 Rogue Series Clamp-On Heat Shield • Battery Wrap Heat Shield • Adhesive-Backed Heat Barrier • 24 K Heat Barrier
- 22-23 Thermo-Shield™ • Cool Air Tube Heat Shield • Starter Heat Shield • Ultra-Lite Insulating Mat
- 24-25 Aluminized Heat Barrier • Aramid Heat Barrier • Muffler / Cat Heat Shield

NEW PRODUCTS

WHAT'S NEW



Proud Supporter of
**WOUNDED WARRIOR
PROJECT**

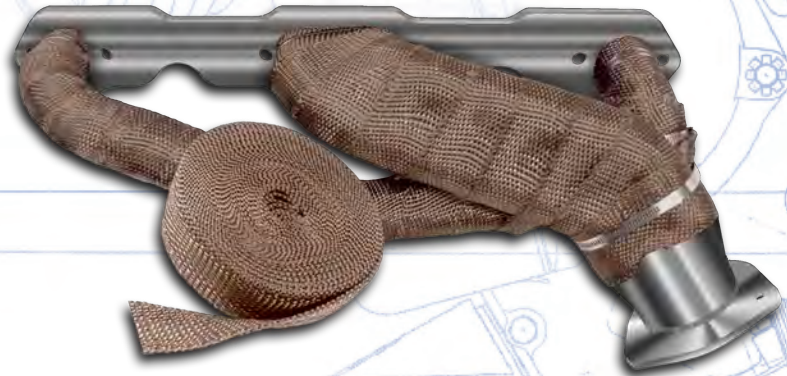

**Rogue Series Exhaust
Insulating Wrap - Page 5**

Form and function come together in the all new Rogue Series, an entirely new line-up of basalt heat insulation products from industry leader Thermo-Tec. For over 30 years, Thermo-Tec has been the go-to source for heat and sound issue solutions in street performance and racing applications.



**Rogue Series Turbo
Cover / Kit - Page 11**



**Rogue Series Clamp-On
Heat Shields - Page 20**

EXHAUST INSULATING



ROGUE SERIES EXHAUST INSULATING WRAP

Hi-Tech Carbon Fiber appearance and Titanium like strength, our Rogue Series Exhaust Insulating Wrap is produced utilizing pulverized Lava rock called basalt. It is extremely pliable, resistant to discoloration and can withstand 2000 degrees Fahrenheit in direct continuous contact.

Sold in 1 or 2 inch wide, 50 foot rolls.

ROGUE Exhaust Wrap

Part #	Product Description
11041	1 in. x 50 ft. Carbon
11071	1 in. x 50 ft. Ricochet
11042	2 in. x 50 ft. Carbon
11072	2 in. x 50 ft. Ricochet



PLATINUM EXHAUST INSULATING WRAP

The Platinum Exhaust Insulating wrap utilizes an exclusive hybrid construction featuring Thermal Conduction Technology (TCT™).

The proprietary Weave Lock design provides durability and minimizes fraying. Helps reduce underhood temperatures, can withstand radiant heat up to 2000°F and can add horsepower to your engine.

Sold in 1 or 2 inch wide, 50 foot rolls.

Platinum Exhaust Wrap

Part #	Product Description
11061	1 in. x 50 ft.
11062	2 in. x 50 ft.



EXHAUST INSULATING

EXHAUST INSULATING WRAP

The original Exhaust Insulating Wrap was developed over 25 years ago by Thermo-Tec.

Wrapping headers with Exhaust Insulating Wrap maintains hotter exhaust gases that exit the system faster through decreased density. This produces increased exhaust scavenging, along with lower intake temperatures. Our Exhaust Wrap withstands continuous heat up to 2000°F; it contains no asbestos.

Thermo-Tec Exhaust Insulating Wrap will not over-insulate a system when properly installed due to a proprietary coating, Thermal Conduction Technology (TCT™), developed by Thermo-Tec, that conducts heat across the Wrap's surface. This unique coating controls heat build-up and dissipation.

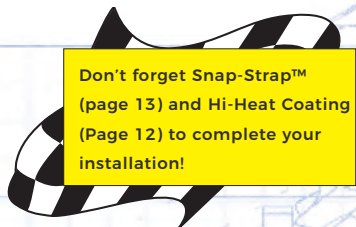

ORIGINAL WRAP	
Part #	Product Description
11001	1 in. x 1/16 in. x 50 ft.
11002	2 in. x 1/16 in. x 50 ft.
11003	2 in. x 1/16 in. x 100 ft.
11151	1 in. x 1/16 in. x 15 ft.
11152	2 in. x 1/16 in. x 15 ft.
11006	6 in. x 1/16 in. x 100 ft.



Graphite Black Wrap	
Part #	Product Description
11021	1 in. x 1/16 in. x 50 ft.
11022	2 in. x 1/16 in. x 50 ft.
11023	2 in. x 1/16 in. x 100 ft.
11153	1 in. x 1/16 in. x 15 ft.
11154	2 in. x 1/16 in. x 15 ft.

EXHAUST INSULATING

GENERATION II COPPER EXHAUST INSULATING WRAP



Generation II Copper Header Wrap improves heat resistance up to 30% more than current technology, by utilizing a proprietary coating developed by Thermo-Tec; improved Thermal Conduction Technology (TCT™).

Generation II Copper Exhaust Wrap is sold in 50 foot rolls, 1 and 2 inch widths, with a low profile 1/16" thickness.

Gen. II Copper Wrap	
Part #	Product Description
11031	1 in. x 50 ft.
11032	2 in. x 50 ft.

EXHAUST INSULATING WRAP KIT



Everything you need for a complete, professional installation of our Exhaust Insulating Wrap, all in one package. Kits include Exhaust Insulating Wrap, Hi-Heat Coating and Snap Straps™.

They are available in Black and Original; two sizes, one for motorcycles and 4-cyl., and one for 6-8 cyl. applications.

Exhaust Wrap Kits	
Part #	Product Description
19102	Original, One Roll Kit
19202	Original, Two Roll Kit
19122	Black, One Roll Kit
19222	Black, Two Roll Kit



EXHAUST INSULATING

HIGH VELOCITY EXHAUST JACKETS

The new quick-wrap high-velocity Exhaust Jackets are an innovative way to insulate and block radiant heat. The jackets cover the tubes vertically allowing for a consistent fit. The fit allows the exhaust system to expand as it comes up to operating temperatures without restrictions and provides air space for added insulation.

This product uses Thermal Conduction Technology (TCT™), developed by Thermo-Tec, and can be applied with the headers mounted in the vehicle.



Great for wrapping cast iron, and RV installations.

Exhaust Jackets	
Part #	Product Description
11246	4-6 Cylinder Kit (12 ft.)
11248	8 Cylinder Kit (16 ft.)

Kits include all necessary hardware and fasteners

HEADER MANIFOLD BLANKET

The Header Manifold Blanket provides excellent heat retention for exhaust headers and manifolds. This flexible heat shield simply clips into place on the upper portion of the header. The fabric side of the material faces the heat source; the aluminized side faces away, offering protection from abrasion and harmful liquid spills.

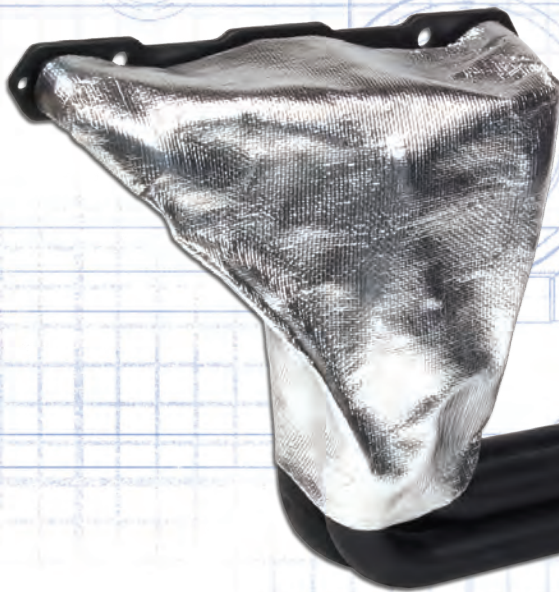

Header Manifold Blanket	
Part #	Product Description
14003	V-6 and V-8
14004	4-Cylinder & Straight-6

Kits include all necessary hardware and fasteners

EXHAUST INSULATING

STAINLESS STEEL

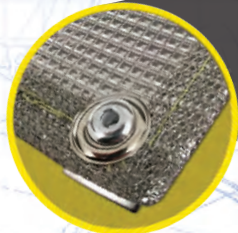

STAINLESS STEEL CLAMP-ON HEAT SHIELD

An updated version of our award winning Clamp-On Heat Shield featuring a rugged textured stainless steel exterior with wire mesh edging, this flexible heat shield is highly effective in blocking and re-directing exhaust heat.

This easy to install heat shield will protect vital components and lines by blocking up to 95% of radiant heat.

Stainless Steel Clamp-On

Part #	Product Description
11675	1 ft. x 6 in. Kit
11676	2 ft. x 6 in. Kit

Blocks over 95% of radiant heat and installs in minutes.



CLAMP-ON HEAT SHIELD

The flexible Clamp-On pipe Heat Shield blocks over 95% of the damaging radiant heat from the exhaust.

The high-tech composite construction of the heat shield provides the ultimate in protection. Our Clamp-On Heat Shields incorporate Thermo-Tec's proprietary coating technology, TCT™.

Clamp-On Heat Shield

Part #	Product Description
11600	6 in. x 1 ft. Kit
11604	6 in. x 1 ft., 4 in. Clamps
11620	6 in. x 2 ft. Kit
11624	6 in. x 2 ft., 4 in. Clamps
11630	6 in. x 3 ft. Kit
11634	6 in. x 3 ft., 4 in. Clamps
11650	4 in. x 1 ft. Kit
11660	4 in. x 2 ft. Kit



EXHAUST INSULATING

TURBO INSULATING KIT

The Turbo Kit is an affordable way to improve performance and eliminate turbo lag.

This universal kit will fit a wide variety of turbines and help protect components by reducing under-hood temperatures caused by the extreme turbo heat.



Blocks over 95% of radiant heat and installs on any size turbo, from sport compact to heavy-duty diesel truck.

Turbo Insulating Kit	
Part #	Product Description
15001	4 Cylinder Kit
15002	6 & 8 Cylinder Kit
15003	Insulation Cover Only

T3-T4 & T5-T6 TURBO COVER

Two easy-fit designs for a T3-T4 or T5-T6 turbine. The turbo cover keeps the turbine spooled up, reducing turbo lag.

Dual layer construction increases performance and durability, reduces under hood temperatures, improves horsepower and performance by maintaining temperatures inside the turbo.



Easy installation cover installs in minutes with wire through grommets

T3-T4 & T5-T6 Turbo Cover	
Part #	Product Description
15004	Kit fits T3, T4
15005	Kit fits T5, T6

Both kits include grommets and wiring

EXHAUST INSULATING



ROGUE TURBO COVER / KIT

The new, easy fit design of the Rogue Series Turbo Cover keeps the turbine spooled up, reducing turbo lag.

The dual layer construction increases performance and durability, reduces under hood temperatures, improves horsepower and performance by maintaining temperatures inside the turbo.



ROGUE Turbo Cover / Kit	
Part #	Product Description
15043	T3 Carbon Fiber Cover
15041	T3 Carbon Fiber Kit
15073	T3 Ricochet Cover
15071	T3 Ricochet Kit
15044	T4 Carbon Fiber Cover
15042	T4 Carbon Fiber Kit
15074	T4 Ricochet Cover
15072	T4 Ricochet Kit

Includes grommets and wiring

ARAMID MUFFLER COVER

Made with our Aramid Heat Barrier, this universal muffler cover can withstand radiant heat up to 3000°F and direct heat up to 800°F. Installing this cover will reduce radiant heat, dampen muffler noise and vibration.

Material is abrasion resistant, with a neat attractive appearance. Cover includes stainless steel straps for installation.

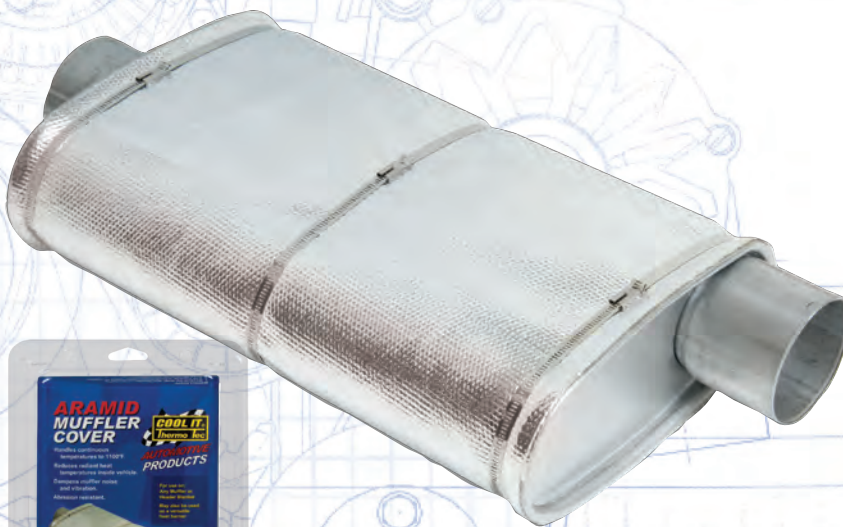

Withstands radiant temperatures up to 3000°F, direct heat up to 800°F

Aramid Muffler Cover	
Part #	Product Description
16800	40 in. x 26 in. with 24" straps



COATINGS & ADHESIVES

HI-HEAT COATING™

Engineered to protect our Exhaust Insulating Wraps from abrasion, harmful fluids as well as the elements such as dirt, grime and water.

Hi-Heat Coating can withstand 2000°F when used in conjunction with genuine Thermo-Tec Exhaust Insulating Wraps.

Additionally, this coating can be used as high-temperature paint on surfaces at temperatures up to 1200°F.



Hi-Heat Coating™	
Part #	Product Description
12001	Black, 11 oz.
12002	Aluminum, 11 oz.
12003	Copper, 11 oz.

HEAVY-DUTY SPRAY ADHESIVE

Perfect for installing genuine Thermo-Tec materials, this temperature resistant contact-style cement is fast drying and will insure a long-lasting bond on a variety of materials.

Use it wherever you need a strong, secure, long-lasting, easy-to-apply bond. It is available in a generous 16 oz. can.



Perfect for heavy-duty applications. Fast-drying, quick-bonding, and high-temperature contact adhesive.

Heavy-Duty Spray Adhesive	
Part #	Product Description
12005	16 oz.

FASTENERS, TAPES, ROLLERS

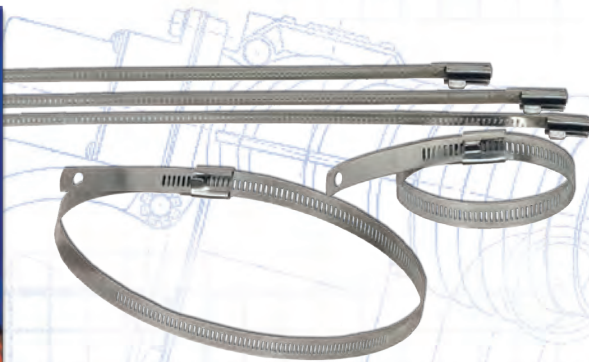

SNAP STRAP™

Use the Multi-purpose stainless steel Snap-Strap to secure your genuine Thermo-Tec Exhaust Wrap or as a multi-purpose fastener in any environment that is exposed to extreme heat.

These low-profile fasteners can be cut to size and feature a multi-lock system for a guaranteed safe and secure fit.

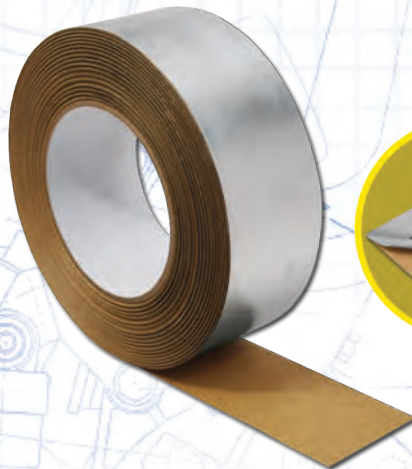

SEAM TAPE

Seam Tape consists of a 2-layer, highly reflective foil with a special acrylic adhesive system. This flame retardant tape is highly puncture proof, tear resistant, and features superior adhesion even under the most extreme conditions.

This high quality tape is great for taping seams of Thermo-Tec's heat and sound barriers, producing a continuous heat barrier and neat professional look.

Seam Tape	
Part #	Product Description
13997	2 in. x 30 ft., Silver



MAT ROLLER

The Mat Roller is a heavy-duty 2 in. roller used to smooth out adhesive installations to provide a seamless finish. It is ideal for removing air bubbles and flattening imperfections for a perfect look.

The ergonomic, non-slip, cushioned handle allows for extra comfort & control. The Mat Roller's styling offers easy reach into corners and tight spaces.

Mat Roller	
Part #	Product Description
14800	2 in. roller



SOUND & HEAT BARRIERS

COOL-IT MAT™

Battle excessive heat and noise with the Cool-It Mat™. It is composed of resin-bonded silica blanketing insulation sandwiched between a reflective Mylar facing on one side and a foil facing on the other.

Reflects heat up to 2000°F away from surfaces providing the ultimate in heat protection. It is an excellent sound insulator. The Cool-It Mat is easy to trim and can be applied with the push-in fasteners provided, or Heavy-Duty Spray Adhesive.

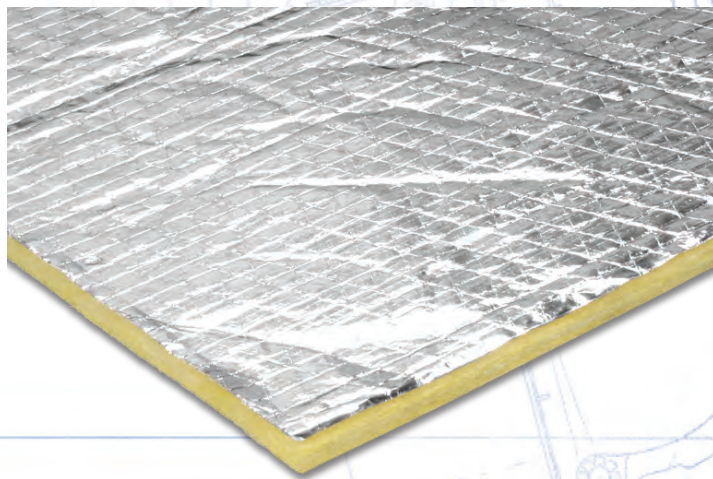

Cool-It Mat™	
Part #	Product Description
14100	24 in. x 48 in.
14110	48 in. x 48 in.
14100-50	24 in. x 50 ft. roll



Use the Heavy-Duty Spray Adhesive (page 12) to easily install both Cool-It Mat™ and Thermo Guard FR™

THERMO GUARD FR™

Thermo Guard FR offers the best in heat and sound insulation. This lightweight, durable shield does everything: reduces sound, absorbs vibration, protects from radiant heat and provides an extra layer of insulating padding.

Features 100% synthetic fiber felt that provides sound and comfort control and a high-tech foil heat barrier that blocks over 90% of radiant heat.

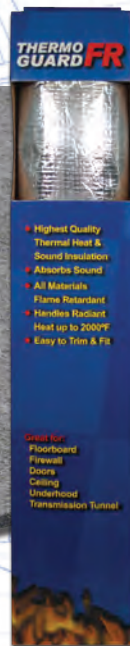
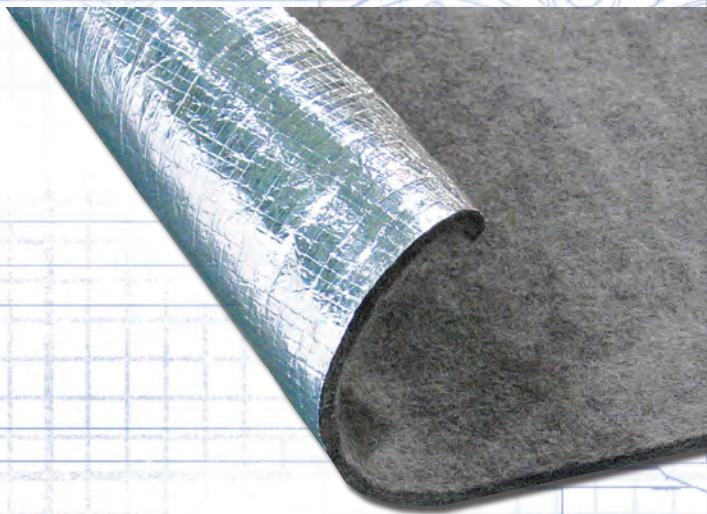

Thermo Guard FR™	
Part #	Product Description
14120	48 in. x 72 in., one-side foil
14125	48 in. x 72 in., two-side foil
14130	24 in. x 48 in., one-side foil

Can be installed where you need to block heat and dampen sound, works great on floors, in doors, within headliner and under the hood. The material conforms to Motor Vehicle Safety Standard 302.

SOUND & HEAT BARRIERS



THE SUPPRESSOR™ HEAT & ACOUSTICAL CONTROL MAT

The Suppressor™ is ideal in areas where vibration, sound, and heat control are desired. In addition to the polyethylene film, the foil surface provides direct protection from radiant heat up to 2000°F and direct temperatures up to 300°F.

Great for areas like firewalls, floorboards, or doors.

The Suppressor	
Part #	Product Description
14600	12 in. x 12 in. (2 pcs)
14610	24 in. x 36 in.
14620	36 in. x 60 in.



Use the Mat Roller (page 13) to easily install both The Suppressor™ and Super Sonic Mats

SUPER SONIC ACOUSTICAL MAT

This high quality mat offers superior sound dampening control to reduce road noise, rattles, engine noise, and any other noises that are bothersome.

The high-density polyethylene film with an aluminum foil composite is abrasion and tear resistant. The gray film provides structural integrity & strength, allowing the material to bend, move and return to shape even under tension forces.



Super Sonic Acoustical Mat	
Part #	Product Description
14700	12 in. x 12 in. (2 pcs)
14710	24 in. x 36 in.
14720	36 in. x 60 in.



SLEEVING

THERMO-SLEEVE™

Thermo-Sleeve™ provides the ultimate protection from radiant heat for hoses and wires. Thermo Sleeve's ultra-lightweight construction provides more insulating than traditional bulky rubber-coated e-glass.

The aluminized sleeving reflects over 90% of radiant heat, and is fireproof and oil resistant. Thermo-Sleeve™ is offered in 3, 12 and 50 foot lengths and 5 inside diameter sizes.



Thermo Sleeve™	
Part #	Product Description
14005	1/2 in. x 3 ft.
14006	1/2 in. x 12 ft.
14005-50	1/2 in. x 50 ft.
14010	1 in. x 3 ft.
14011	1 in. x 12 ft.
14010-50	1 in. x 50 ft.
14015	1 1/2 in. x 3 ft.
14016	1 1/2 in. x 12 ft.
14015-50	1 1/2 in. x 50 ft.
14020	2 in. x 3 ft.
14021	2 in. x 12 ft.
14020-50	2 in. x 50 ft.
14025	2 1/2 in. x 3 ft.
14026	2 1/2 in. x 12 ft.
14025-50	2 1/2 in. x 50 ft.

Part #	SAE	O.D.
14005, 6	4	7/16 in.
14010, 11	6	7/32 in.
	8	21/32 in.
	10	13/16 in.
	12	15/16 in.
14015, 16	16	1-5/32 in.
	20	1-5/32 in.
14020, 21	24	1-11/16 in.
	28	1-13-16 in.
14021, 26	32	2 in.

EXPRESS SLEEVES™

Express Sleeve™ is high temperature insulation within a highly reflective Mylar featuring a hook and loop closure for easy installation and removal. Express Sleeve™ is designed to provide maximum protection from radiant heat for wires, hoses, lines and cables.

Express Sleeves™ reflect over 90% of radiant heat up to 2000°F, can withstand direct continuous temperatures up to 750°F. They are fireproof, fire resistant, and just look good.

Express Sleeves™	
Part #	Product Description
14030	1/2 in. - 1 in. x 3 ft.
14031	1/2 in. - 1 in. x 12 ft.
14030-50	1/2 in. - 1 in. x 50 ft.
14035	1 in. - 1 1/2 in. x 3 ft.
14036	1 in. - 1 1/2 in. x 12 ft.
14035-50	1 in. - 1 1/2 in. x 50 ft.



IGNITION/PLUG WIRE SLEEVING

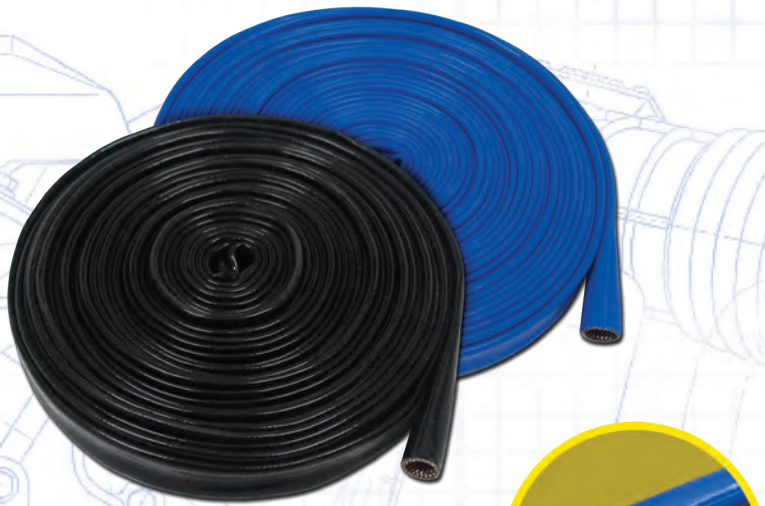

These high temperature sleeves can be used for ignition wires, spark plug wires, and even fuel lines to prevent vapor lock. Highly flexible and abrasion resistant, they offer maximum protection from radiant heat and spark loss.

The interior construction features braided continuous e-glass insulation that can withstand 1000°F and the silicone outer surface is rated for 500°F.

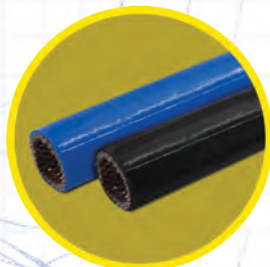

Ignition/Plug Wire Sleeving

Part #	Product Description
14040	3/8 in. x 25 ft. Black
14045	3/8 in. x 25 ft. Blue

COOL-IT™ PLUG WIRE SLEEVES

Spark plug and ignition wire protectors come in four sporty colors: red, blue, black, and natural.

Double wall construction keeps the wire and boot cooler in a high temperature engine. Universal size that will fit most plug boots, simple to install and non-flammable.

Insulate spark plug wires and combine with Cool-It™ Plug Wire Sleeves for the ultimate protection!



Cool-It™ Plug Wire Sleeves

Part #	Product Description
14260	Natural, 4 pack
14261	Red, 4 pack
14262	Black, 4 pack
14263	Blue, 4 pack
14270	Natural, 6 pack
14271	Red, 6 pack
14272	Black, 6 pack
14273	Blue, 6 pack



SLEEVING

SPARK PLUG WIRE HEAT SHIELD

The Spark Plug Wire Heat Shield offers the ultimate protection for spark plug wires and boots from conductive and radiant heat.

The dual purpose sleeve has a surface that reflects over 90% of radiant heat, while the interior silica-based fabric prevents conductive heat from penetrating.

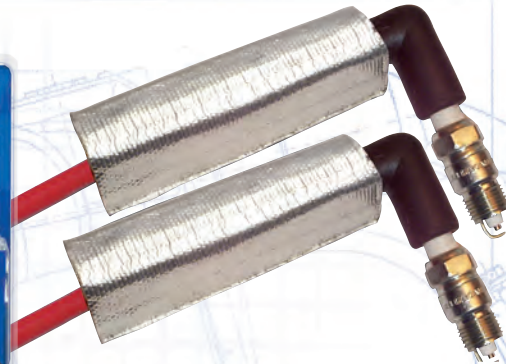

Spark Plug Wire Heat Shield

Part #	Available Sizes
14200	(2) 6 in. x 1-1/2 in.
14250	(4) 6 in. x 1-1/2 in.

HEAT SLEEVES™

High quality sleeving made in the USA from braided e-glass and coated with a compound silicone rubber. Heat Sleeves are capable of continuous protection to 500°F and short term exposure to 2200°F.

Heat Sleeves™	
Part #	Product Description
18050	1/2 in. x 3 ft. Black
18050-10	1/2 in. x 10 ft. Black
18050-50	1/2 in. x 50 ft. Black
18051	1/2 in. x 3 ft. Silver
18051-10	1/2 in. x 10 ft. Silver
18051-50	1/2 in. x 50 ft. Silver
18075	3/4 in. x 3 ft. Black
18075-10	3/4 in. x 10 ft. Black
18075-50	3/4 in. x 50 ft. Black
18076	3/4 in. x 3 ft. Silver
18076-10	3/4 in. x 10 ft. Silver
18076-50	3/4 in. x 50 ft. Silver
18100	1 in. x 3 ft. Black
18100-10	1 in. x 10 ft. Black
18100-50	1 in. x 50 ft. Black
18101	1 in. x 3 ft. Silver
18101-10	1 in. x 10 ft. Silver
18101-50	1 in. x 50 ft. Silver

Protect your wires and hoses with our Heat Sleeves. They protect from harmful spills and staining.





Thermo-Flex is very flexible and makes protecting your important hoses and wires easy!

THERMO-FLEX

Thermo-Flex is an attractive composite sleeving with unlimited uses. The combination of aluminum, silica and stainless steel produces a material that is flexible, lightweight, and strong. It provides abrasion resistance, thermal insulation, and physical containment of hoses and wires.

The versatile sleeving can be slit for applications such as wire looms or hose covering without disconnecting the ends of the wires or hoses. Thermo-Flex can withstand extreme temperatures up to 750°F.



Protect your electrical components like a wire loom



High pressure systems can also be protected from heat



Thermo-Flex	
Part #	Product Description
17062	5/8 in. x 3 ft. Silver
17062-10	5/8 in. x 10 ft. Silver
17063	5/8 in. x 3 ft. Black
17075	3/4 in. x 3 ft. Silver
17075-10	3/4 in. x 10 ft. Silver
17076	3/4 in. x 3 ft. Black
17100	1 in. x 3 ft. Silver
17100-10	1 in. x 10 ft. Silver
17101	1 in. x 3 ft. Black
17125	1 1/4 in. x 3 ft. Silver
17125-10	1 1/4 in. x 10 ft. Silver
17150	1 1/2 in. x 3 ft. Silver
17150-10	1 1/2 in. x 10 ft. Silver
17300	3 in. x 3 ft. Silver
17300-10	3 in. x 10 ft. Silver

The Pros use Thermo-Flex for a clean, organized installation. There is no need to remove wires or hoses, simply slit lengthwise and install.



HEAT SHIELDS & PROTECTION

CLAMP-ON HEAT SHIELDS

For motorcycle and applications involving smaller pipes, the Rogue Series Clamp-On Heat Shields are Thermo-Tec's new and improved way to block exhaust heat.

The high-tech composite construction of this heat shield provides the ultimate in protection.

The kits come complete with all clamps and stainless stand offs and install in minutes.

ROGUE
PERFORMANCE PRODUCTS

NEW

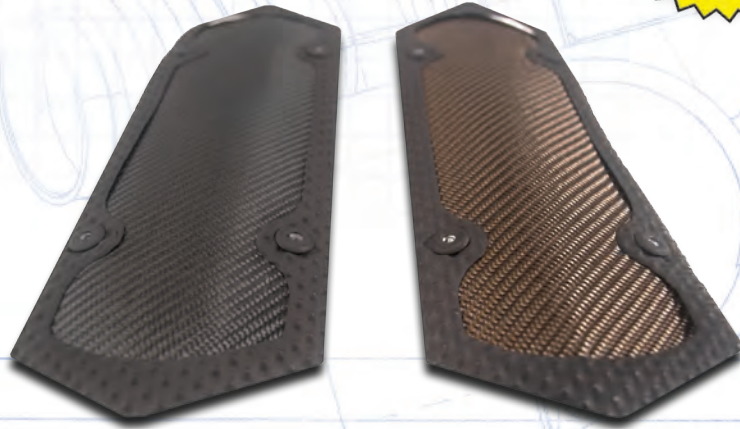

Clamp-On Heat Shields	
Part #	Product Description
11550	3.75 in. x 11.75 in. Carbon Fiber
11500	3.75 in. x 11.75 in. Richocet
11551	3.75 in. x 5.75 in. Carbon Fiber
11501	3.75 in. x 5.75 in. Richocet

BATTERY WRAP HEAT SHIELD

The world's only acid-neutralizing heat barrier mat. It reflects over 90% of radiant heat, traps and neutralizes battery acid, protects against corrosion, is recyclable, protects the environment, is inexpensive and easy to install.

Safe to handle before and during installation.



Extend the life of your battery by protecting it from the extreme environment under the hood.

Battery Wrap Heat Shield	
Part #	Product Description
13200	Batter Wrap Barrier Kit

HEAT SHIELDS & PROTECTION

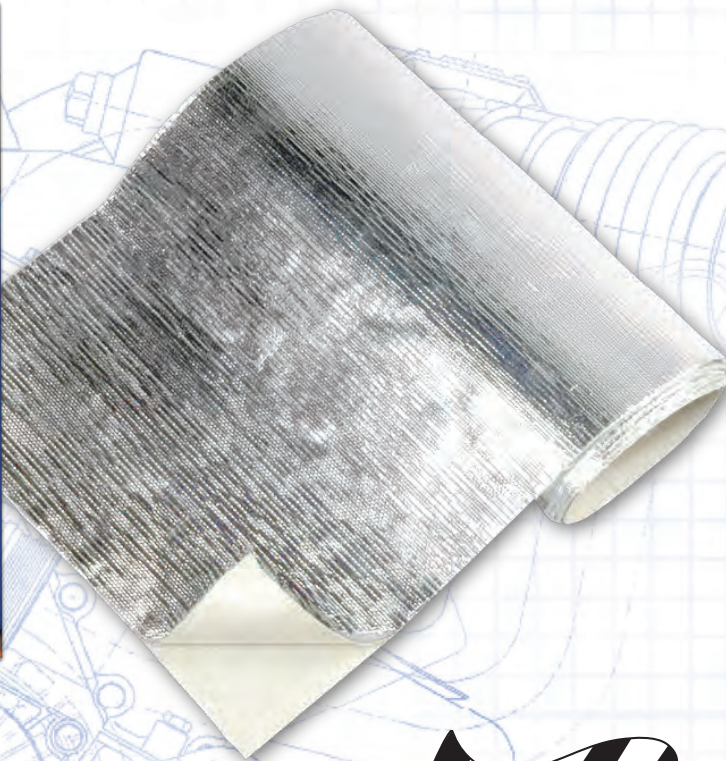
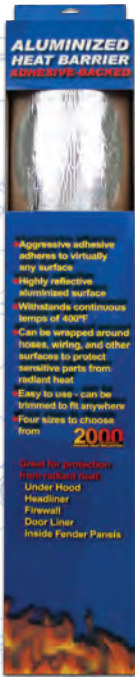

ADHESIVE-BACKED HEAT BARRIER

Protect virtually any surface or component from the damaging effects of radiant heat.

Made up of woven silica with a flexible aluminized finish. The highly reflective surface is capable of withstanding radiant temperatures up to 2000°F. The adhesive side handles direct and continuous temperatures up to 300°F.

Adhesive-Backed Heat Barrier

Part #	Product Description
13500	12 in. x 12 in.
13575	12 in. x 24 in.
13585	24 in. x 36 in.
13590	24 in. x 48 in.
13575-50	12 in. x 50 ft.
13590-50	24 in. x 50 ft.



Use the Mat Roller (page 13) to easily install both Adhesive-Backed and 24 K Heat Barrier

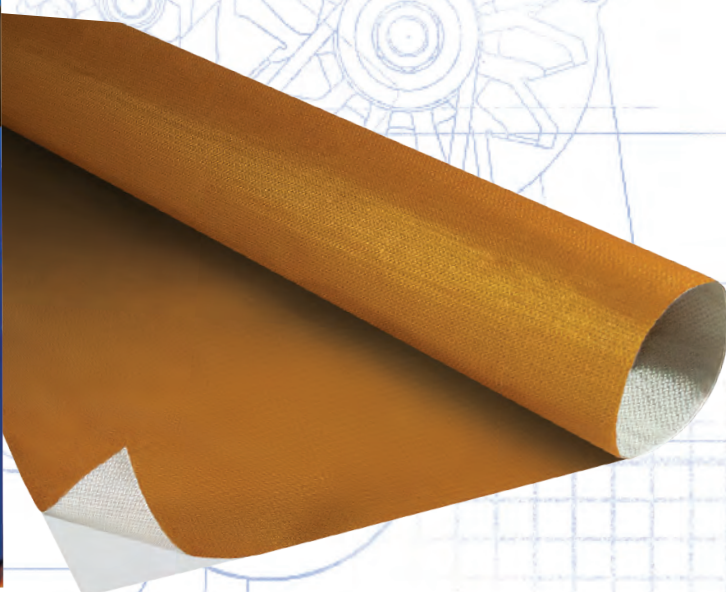
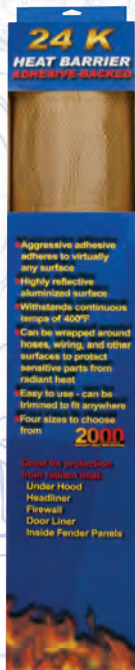

24 K HEAT BARRIER

An excellent insulation product, the 24 K Heat Barrier helps protect vital engine components and provides a barrier against radiant heat up to 2000°F.

Helps lower intake and under hood temperatures. Easily installs virtually anywhere with an adhesive backing.

24 K Heat Barrier

Part #	Product Description
13700	12 in. x 24 in.
13775	24 in. x 24 in.
13775-50	24 in. x 50 ft.
13990	1.5 in. x 15 in.



HEAT SHIELDS & PROTECTION

THERMO-SHIELD™

Protects hoses and wires from radiant heat. Used in applications where it is difficult or not practical to disconnect one end of the hose or wire. Not for use on exhaust.

Adhesive-backed composite construction tape can easily be wrapped around the hose or wire to make a clean, professional appearance. Protects parts from over 90% of radiant heat up to 2000°F.



Thermo-Shield™	
Part #	Product Description
14002	1-1/2 in. x 15 ft.
13995	2 in. x 50 ft. roll

Thermo-Shield™ is extremely easy to install and is great to have on hand for a quick insulating fix.



COOL AIR TUBE HEAT SHIELD

Keep your induction air cool with this easy to install intake tube heat shield. The design of the cover fits from 2-1/2 inch to 3-1/2 inch diameter air tubes, up to 36 inches long. The lace-up heat shield blocks over 98% of radiant heat up to 2000°F and withstand direct continuous temperatures up to 750°F.

The kit comes complete with four different color laces: blue, yellow, red, and white.

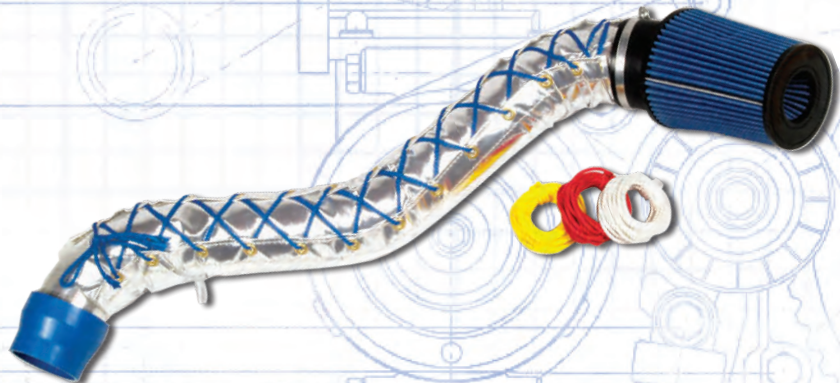

Cool Air Tube Heat Shield	
Part #	Product Description
14500	3 ft. adjustable diameter heat shield including red, blue, white and yellow laces.

Reduce intake temperatures significantly!



HEAT SHIELDS & PROTECTION

STARTER HEAT SHIELD

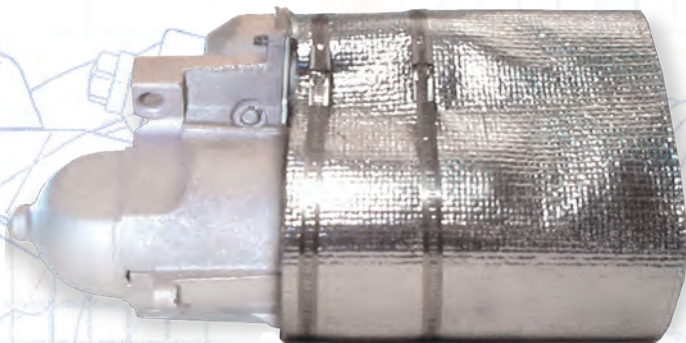

Starters take in a lot of damaging heat that destroys the windings of the starter and solenoid. To combat this problem, Thermo-Tec created a non-conductive strap-on heat shield with a highly reflective Mylar surface.

The Starter Heat Shield reflects over 90% of radiant heat, adding life to the starter and assuring reliable starts. The universal kit fits all starters; it includes two 24 in. Snap Straps™ for easy installation.



Don't get stuck in the summer time heat! The starter heat shield can keep your starter from failing.

Starter Heat Shield

Part #	Product Description
14150	7 in. x 22 in.

ULTRA-LITE INSULATING MAT

Ultra-lite floor-insulating mats are designed with the racer in mind. Made with the highest quality insulating materials available. Highly textured aluminum composite surface on one side, with a high-temp silica felt center and a durable Mylar composite on the other.



Don't get hot feet while racing, use our Ultra-Lite Insulating Mat on your floorboards.



Ultra-Lite Insulating Mat

Part #	Product Description
16510	8 in. x 12 in.
16520	10 in. x 18 in.
16530	18 in. x 18 in.
16540	18 in. x 24 in.
16550	24 in. x 24 in.
16560	24 in. x 36 in.



HEAT SHIELDS & PROTECTION

ALUMINIZED HEAT BARRIER

Made of woven silica with a flexible aluminized finish. The highly reflective surface is capable of withstanding radiant temperatures up to 2000°F; The fabric side can handle temperatures in the range of 350-750°F.

Can be installed using standard rivets with a backup washer or our Heavy-Duty Spray Adhesive. Snap Straps™ can be used to hold the blanket in place around manifolds or exhaust systems.



Aluminized Heat Barrier

Part #	Product Description
14001	40 in. x 36 in.
14001-50	40 in. x 50 ft.

ARAMID HEAT BARRIER

Made from Aramid with a Mylar finish. Withstands up to 3000°F of radiant heat and direct heat contact up to 800°F.

Install using standard rivets with a backup washer or Heavy-Duty Spray Adhesive. Use Snap Straps™ to hold the blanket in place for applications on manifolds or exhaust systems.

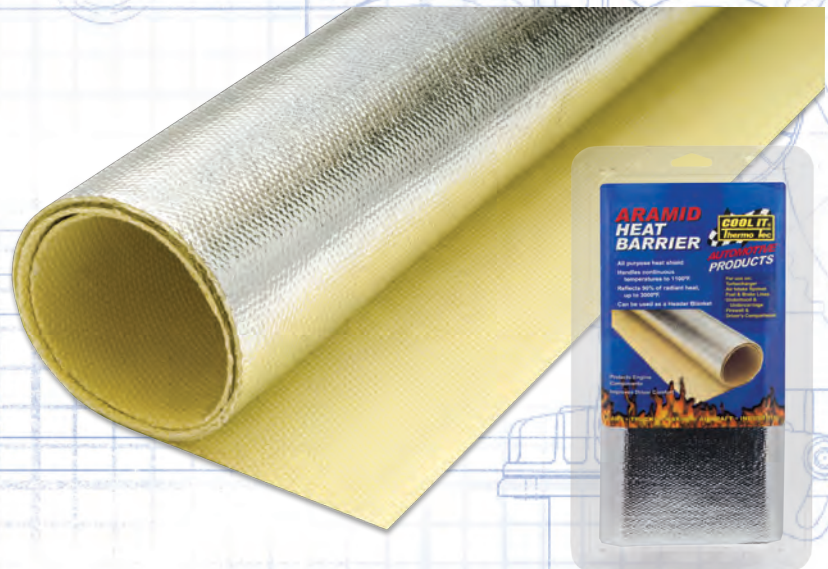

Aramid Heat Barrier

Part #	Product Description
16850	26 in. x 40 in.

HEAT SHIELDS & PROTECTION



MUFFLER / CAT HEAT SHIELD

The Muffler/Catalytic Converter Heat Shield is made up of woven silica with a flexible Mylar finish that protects against radiant heat up to 2000°F; the fabric side withstands direct continuous temperatures up to 800°F. The highly reflective heat shield can be installed between the catalytic converter, muffler, or any other component to reflect radiant heat away from the under carriage of the car.

This material can be installed using our Heavy-Duty Spray Adhesive, rivets or the included fasteners.

Muffler / Cat Heat Shield	
Part #	Product Description
16500	24 in. x 40 in. Mylar

Award winning racers and builders rely on
Thermo-Tec when only the best will do!



OVER 30 YEARS OF INNOVATION



A GLIMPSE INTO THE PAST...

For over 30 years, our family-owned business has provided top-quality heat and sound insulation products for high-performance vehicles.

We're not only the best in the business – we're the original.

Our innovations have orbited in space, braved the elements with our men and women in uniform, and reached high speeds with racers around the world, from Jack Roush to Joe Gibbs to weekend warriors like you. And when you purchase a product from Thermo-Tec, you support the U.S. economy by buying parts produced by American technology and American hands.

We stand by our products and guarantee you'll be pleased with the quality and value of your purchase. Pick the right solution first with Thermo-Tec!

Chrissy Gilmore
CEO



NOTES

FIG-52 10 Min

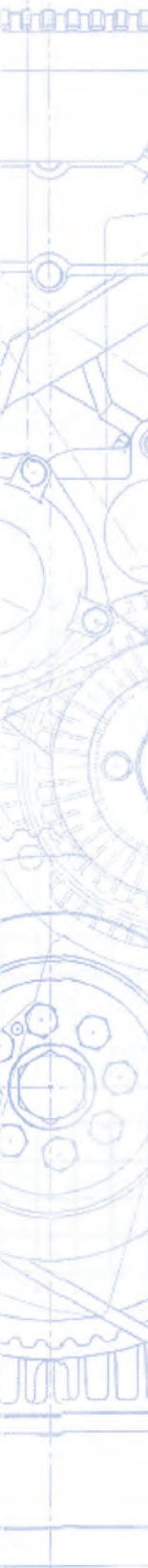



THERMO-TEC AUTOMOTIVE, INC.

P.O. Box 96
Greenwich, OH 44837 USA

(800) 274-8437 Toll-free

(419) 962-4013 Fax

(419) 962-4556 Outside USA

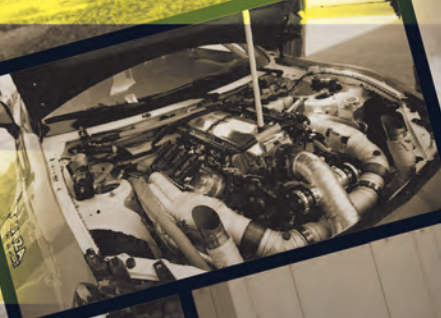

Like us, follow us and watch us

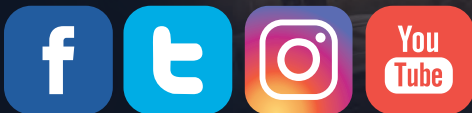

facebook.com/thermotec
twitter.com/thermotec
instagram.com/thermotec
youtube.com/thermotecusa

#0118

DISTRIBUTED BY:



Proud Supporter of
**WOUNDED WARRIOR
PROJECT**

**Performance
Racing Industry**

www.thermotec.com

© 2018 Thermo-Tec Automotive Inc.